

## INSTALLATION MANUAL

# AIR CONDITIONER

Please read this installation manual completely before installing the product.  
Installation work must be performed in accordance with the national wiring standards by authorized personnel only.  
Please retain this installation manual for future reference after reading it thoroughly.

VENTILATOR

Original instruction



MFL67855541  
Rev.04\_031022



[www.lg.com](http://www.lg.com)

Copyright © 2018 - 2022 LG Electronics Inc. All Rights Reserved.

РУССКИЙ ЯЗЫК

ENGLISH

УКРАЇНСЬКА

ITALIANO

ҚАЗАҚ ТІЛІ

ESPAÑOL

БЕЛАРУСКАЯ МОВА

FRANÇAIS

ЎЗБЕК ТИЛИ

DEUTSCH

ЕАМНИКА

ČEŠTINA

NEDERLANDS

POLSKI

ЛМБА РОМÂNĂ

# TABLE OF CONTENTS

## 3 Safety precautions

---

- 9 Preparing for operation
- 9 Service
- 9 Precautions for installing a Wi-Fi modem

## 10 Introduction

---

- 10 Symbols used in this manual
- 10 Feature dimension diagram

## 15 Installation

---

- 15 Installation map (150 / 200 CMH)
- 16 Installation map (250 / 350 / 500 / 800 / 1 000 CMH)
- 17 Installation map (1 500 / 2 000 CMH)
- 18 Installation of main body
- 18 Connection of duct
- 20 Method to connect power cord
- 22 How to connect remote controller(accessory)
- 23 How to use the filter check alarm function by filter clogging (800/1000/1500/2000 CMH)
- 24 Group control
- 25 Installer setting - How to enter installer setting mode

## 28 Test running

---

- 28 Method to operate and select air volume - Interlinked operation with ventilation
- 29 Ventilation product user manual - Single operation with general ventilation
- 30 In case of finding a problem at a test running
- 30 Airborne noise emission

# Safety precautions



To prevent injury to the user or other people and property damage, the following instructions must be followed.

Incorrect operation due to ignoring instruction will cause harm or damage. The seriousness is classified by the following indications.

**⚠ WARNING** This symbol indicates the possibility of death or serious injury.

**⚠ CAUTION** This symbol indicates the possibility of injury or damage.

Meanings of symbols used in this manual are as shown below.

	<b>Be sure not to do.</b>
	<b>Be sure to follow the instruction.</b>

## ⚠ WARNING

### Installation

- Do not use a defective or underrated circuit breaker. Use this appliance on a dedicated circuit.
  - There is risk of fire or electric shock.
- For electrical work, contact the dealer, seller, a qualified electrician, or an authorized service center.
  - Do not disassemble or repair the product. There is risk of fire or electric shock.
- Always ground the product.
  - There is risk of fire or electric shock.
- Install the panel and the cover of control box securely.
  - There is risk of fire or electric shock.
- Always install a dedicated circuit and breaker.
  - Improper wiring or installation may cause fire or electric shock
- Use the correctly rated breaker or fuse.
  - There is risk of fire or electric shock.
- Do not modify or extend the power cable.
  - There is risk of fire or electric shock.

- Do not install, remove, or re-install the unit by yourself (customer).
  - There is risk of fire, electric shock, explosion, or injury.
- Be cautious when unpacking and installing the product.
  - Sharp edges could cause injury.
- The fan is to be installed so that the blades are more than 2.3 m above the floor.
- For installation, always contact the dealer or an authorized service center.
  - There is risk of fire, electric shock, explosion, or injury.
- Do not install the product on a defective installation stand.
  - It may cause injury, accident, or damage to the product.
- Do not let the product run for a long time when the humidity is very high and a door or a window is left open.
  - Moisture may condense and wet or damage furniture.
- For re-installation of the installed product, always contact the dealer or an authorized service center.
  - There is risk of fire, electric shock, explosion or injury.
- Do not open the maintenance cover of the main body during operation.
  - Otherwise, it may cause electrical shock.
- Use the outdoor air suction hole with the net installed to ensure that birds could not come in.
  - Remove estrange things like the bird's nest. Otherwise, it may cause scarcity of indoor oxygen.
- Install the air intake where polluted air can not be directly sucked in.
  - It may cause various accidents, including suffocation, due to the suction of harmful gasses(CO, etc.)
- Do not install this product in a refrigerated warehouse, heated swimming pool or other location where the temperature and humidity are significantly different.
  - There is risk of electrical shock, malfunctioning.
- Install this product in an environment where the temperature ranges from -10 °C to +45 °C and the relative humidity is less than 80 %. It condensation is expected to form, heat up the fresh outside air using a duct heater etc.
- Install this product in and environments where the outside air intake meets the following conditions: temperature range is between -15 °C and +40 °C and the relative humidity is 80 % or less.

- Use the designated electrical wires for the terminal board connections, and connect the wires securely so that they will not become disconnected. (Failure to ensure proper connections may cause fire.)
- When passing metal ducts through wooden buildings clad with metal laths, wire laths or metal, these ducts must be installed in such a way that they will not make electrical contact with the metal laths, wire laths or metal sheets. (Power leakage can cause ignition)
- Means for disconnection must be incorporated in the fixed wiring in accordance with the wiring rules.

## **Operation**

- When the product is soaked (flooded or submerged), contact an authorized service center.
  - There is risk of fire or electric shock.
- Don't touch a dedicated circuit or breaker with wet hands.
  - There is risk of electric shock.
- When the product is not be used for a long time, disconnect the power supply plug or turn off the breaker.
  - There is risk of product damage or failure, or unintended operation.
- When flammable gas leaks, turn off the gas and open a window for ventilation before turn the product on.
  - Do not use the telephone or turn switches on or off.
  - There is risk of explosion or fire.
- Be cautious that water could not enter the product.
  - There is risk of fire, electric shock, or product damage.
- Turn the breaker off when cleaning or maintaining the product.
  - There is risk of electric shock.
- The outside ducts must be tilted at a gradient (1/30 or more) down toward the outdoor area from the ventilator unit, and properly insulated. (The entry of rain water may cause power leaks, fire or damage to household property.)
- Glove should be worn when doing the installation work. (There is risk of injury.)

**The following content is for models with the UVnano function.**

- Be sure to turn off the main power for installation, service, and repair of the UV LED.
  - It may cause electric shock, injury, or death.
- When installing, servicing, or repairing the UV LED, the modules provided by LG Electronics must be used. If necessary, please contact an LG Electronics Service Center.
  - \* UV LED Module Information : LTPL-G35U275GS-TWA
- This product is equipped with a UV-C lamp (UV LED). Do not stare at the UV LED.
  - Injury may occur.
- If the UV LED is damaged or needs to be replaced, please contact an LG Electronics Service Center.
  - Injury may occur.
- Do not operate the UV LED outside the product.
  - Injury may occur.
- Do not remove the parts inside the product with UV risk symbols. UV C may be released from the UV LED.
  - Injury may occur.
- Be careful as UV C may be released to the outside due to unintended use of the product or damage to the product. UV C can harm the eyes and skin even if the exposure is small.
- Do not touch or clean the product while the UVnano function is operating.
- The UV LED is a part that does not require cleaning. Do not separately clean parts with UV risk labels or the UV LED.
  - Injury may occur.
- UVnano is a compound word of UV(ultraviolet)LED and nanometers, the unit of ultraviolet wavelength.
- When the product is powered off or the access door is opened, the UVnano sterilization function stops.
- If UV LED repair is required while using the UVnano function, a UV indicator occurs on the remote controller.
- Depending on the model, some functions may not be displayed/operate or be different.

- This appliance contains a UV emitter. Do not stare at the light source.
- Doors and access panels bearing the ultraviolet radiation hazard symbol which may have UV-C spectral irradiance greater than  $1,7 \mu\text{W}/\text{cm}^2$  are provided with an interlock switch to interrupt the power to the UV-C lamps for your safety. Do not over-ride.
- UV-C barriers bearing the ultraviolet radiation hazard symbol should not be removed.
- For appliances with UV-C lamps, information on the replacement of UV-C lamps shall be given, including the model and/or part number.
- If field installed, the factory specified UV-C germicidal lamp systems approved for use with the subject product shall be specified in the instructions by the specific model number.

---

---

**⚠ CAUTION**

---

---

### Installation

- Don't connect the ground wire to the window frame or water cock.
  - There is risk of electric shock.
- Do not install the product at a smoky and oily place like kitchen or factory.
  - Otherwise. oil may adhere to the filter or heating exchanger and cause trouble.
- Install the product in an insulated space from outdoor air.
  - In case of installing the product outside of the insulated layer, dewing occurs inside of the main body in winter. And it causes electrical shock or falling of condensed water.
- Keep level even when installing the product.
  - To avoid vibration or water leakage.
- Use two or more people to lift and transport the product.
  - Avoid personal injury.
- Do not install the product where it will be exposed to sea wind (salt spray) directly.
  - It may cause corrosion on the product. Corrosion, particularly on the condenser and evaporator fins, could cause product malfunction or inefficient operation.
- Do not install or use the product in places at risk of explosion.
  - It may cause fire or explosion.

## **Operation**

- Use a soft cloth to clean. Do not use harsh detergents, wax or thinner, etc.
  - Otherwise, color or surface of the product may deteriorate.
- Clean the filter and the heat exchanger regularly and use the gloves for cleaning.
  - Adhering to a mass of dust may cause the deterioration of air volume.
- Do not use the product for special purposes, such as preserving foods, works of art, etc. It is a consumer ventilator, not a precision refrigeration system.
  - There is risk of damage or loss of property.
- Do not block the inlet or outlet of air flow.
  - It may cause product failure.
- Do not step on or put anything on the product.
  - There is risk of personal injury and failure of product.



## ***Preparing for operation***

1. Contact an installation specialist for installation.
2. Plug in the power plug properly.
3. Use a dedicated circuit.
4. Do not use an extension cord.
5. Do not start/stop operation by plugging/unplugging the power cord.
6. If the supply cord is damaged, it must be replaced by the manufacturer, its service agent or similarly qualified persons in order to avoid a hazard.

## ***Service***

1. For repair and maintenance, contact your authorized service dealer.
2. The appliance shall be disconnected from its power source during service and when replacing parts

## ***Precautions for installing a Wi-Fi modem***

- It should be installed by installation specialist.
- The wireless router must be installed within 10m.
- Install in a space without EMI interference. It may cause malfunction of the product.
- If there is a wall or obstacle between the Wi-Fi modem and the wireless AP, the communication may not be smooth.
- If it is attached to a steel structure such as an H-beam, steel plate, indoor unit cabinet, etc., the communication may not be smooth.
- Use a 10m extension cable (sold separately) according to the installation situation, but do not connect additionally exceeding 10m.
- Install in a place 1cm or more away from a metal panel.

# Introduction

## Symbols used in this manual



This symbol alerts you to the risk of electric shock.



This symbol alerts you to hazards that could cause harm to the product.

**NOTICE**

This symbol indicates special notes.

## Feature dimension diagram

• 150 / 200 CMH

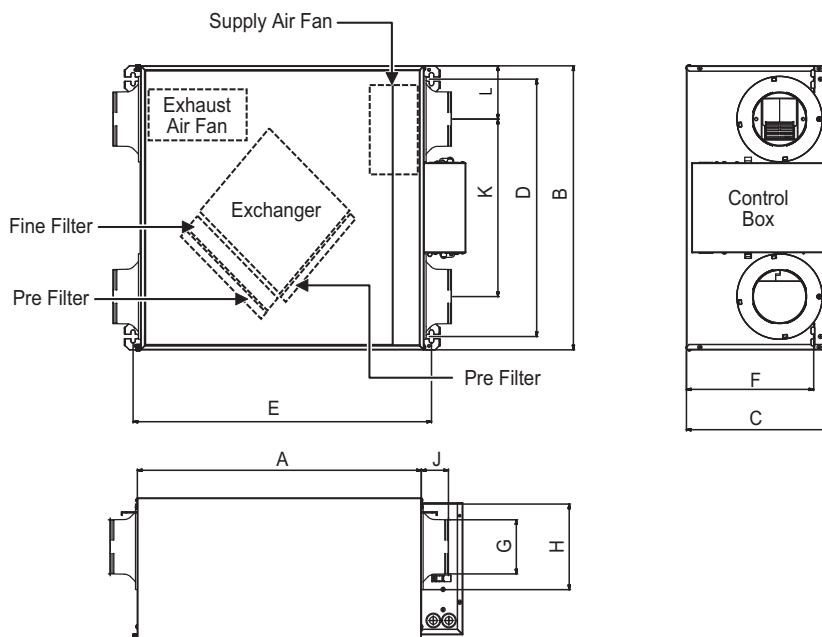

Unit : mm

Capacity	Figure			Pitch of suspension fixture			Nominal diameter	Duct connection flange			Duct pitch		Weight kg
	A	B	C	D	E	F		G	H	J	K	L	
150 CMH 200 CMH	640	640	320	580	673	287	125	122	193	61	400	120	23

\* It necessary to secure sufficient space for maintenance more than the dimensions described in the product service.

## • 250 CMH

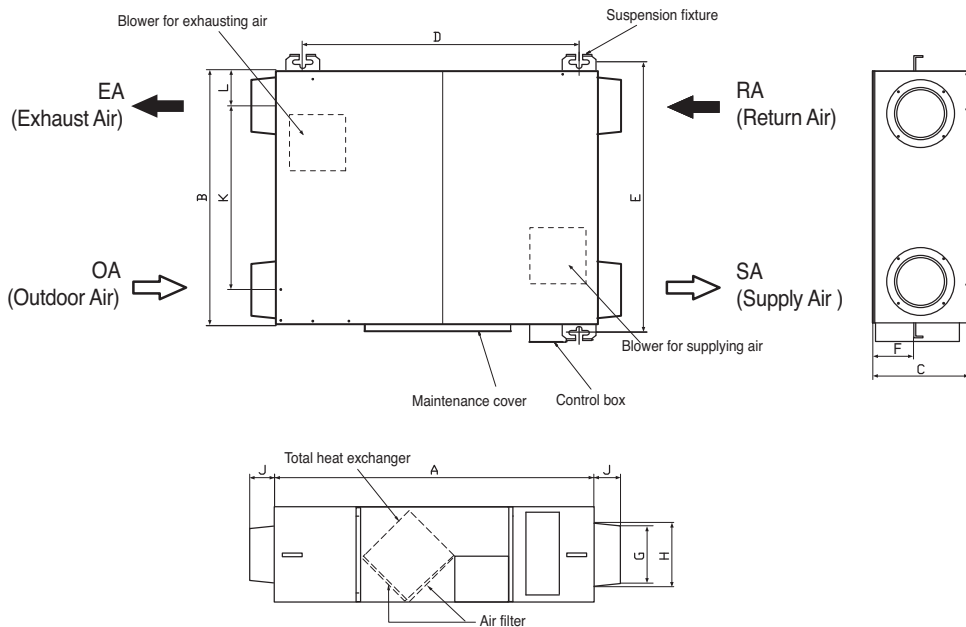

Unit : mm

Capacity	Figure			Pitch of suspension fixture			Nominal diameter	Duct connection flange			Duct pitch		Weight kg
	A	B	C	D	E	F		G	H	J	K	L	
250 CMH	1 014	988	273	939	1 025	135	200	194	252	96	590	198	44

※ It necessary to secure sufficient space for maintenance more than the dimensions described in the product service.

• 350 / 500 CMH

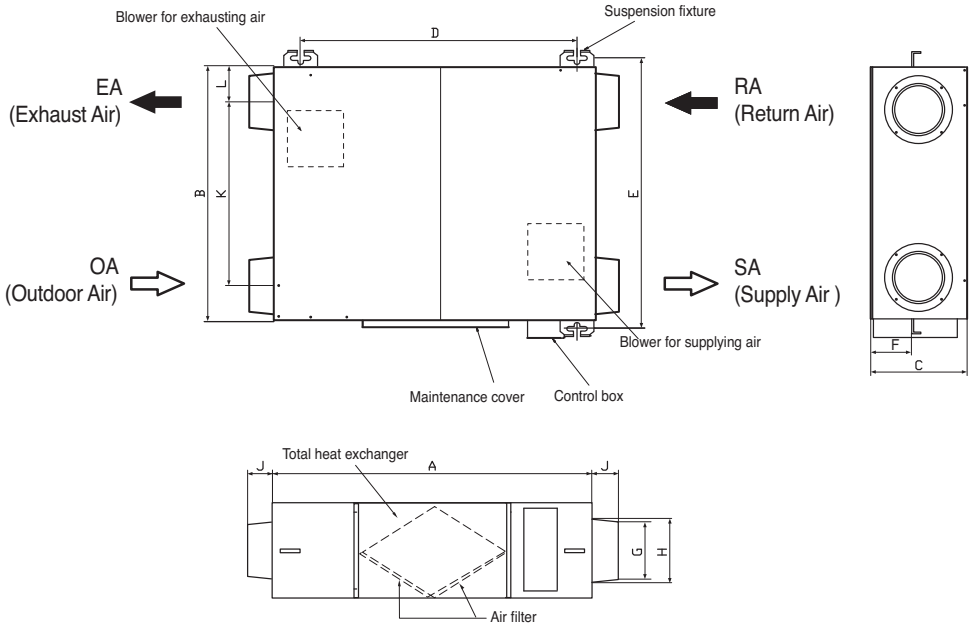

Unit : mm

Capacity	Figure			Pitch of suspension fixture			Nominal diameter	Duct connection flange			Duct pitch		Weight kg
	A	B	C	D	E	F		G	H	J	K	L	
350 CMH 500 CMH	1 014	988	273	939	1 025	135	200	194	252	96	590	198	44

\* It necessary to secure sufficient space for maintenance more than the dimensions described in the product service.

## • 800 / 1 000 CMH

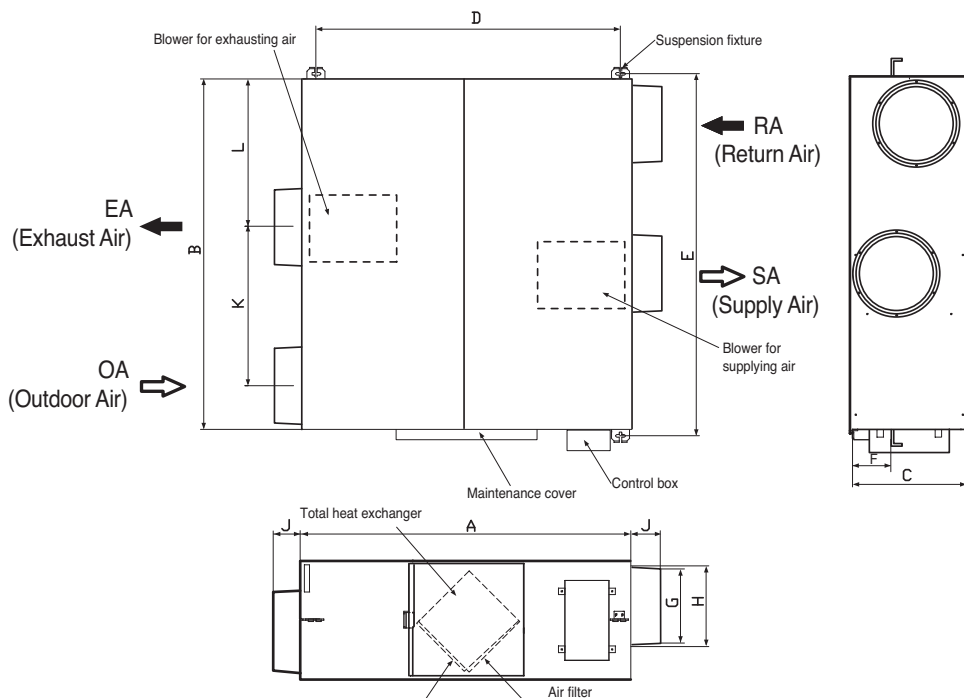

Unit : mm

Capacity	Figure			Pitch of suspension fixture			Nominal diameter	Duct connection flange			Duct pitch		Weight kg
	A	B	C	D	E	F		G	H	J	K	L	
800 CMH 1 000 CMH	1 101	1 230	405	1 026	1 263	269	250	242	253	98	567	519	62.8

\* It necessary to secure sufficient space for maintenance more than the dimensions described in the product service.

• 1 500 / 2 000 CMH

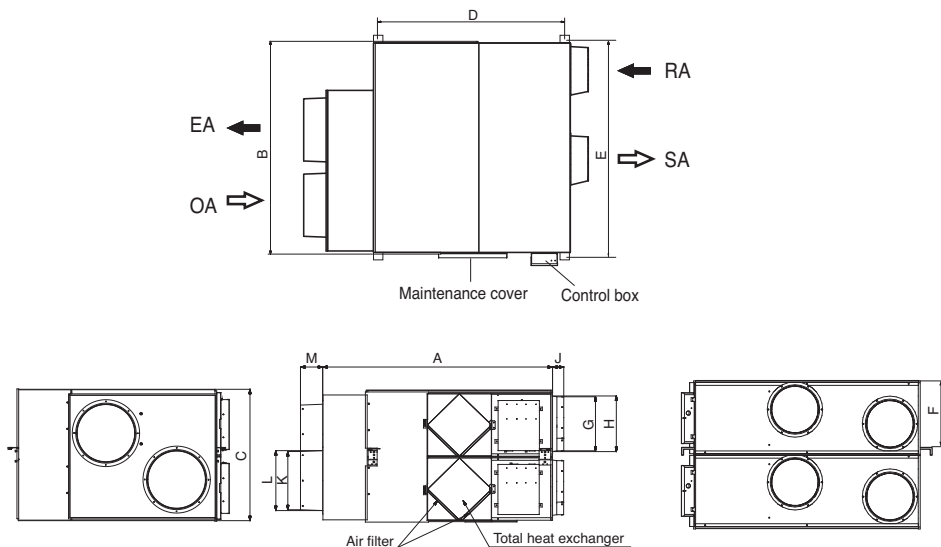

Unit : mm

Capacity	Figure			Pitch of suspension fixture			Duct connection flange						Weight
	A	B	C	D	E	F	G	H	J	K	L	M	Kg
1 500 CMH 2 000 CMH	1 353	1 230	815	1 031	1 288	363	242	253	76	340	350	130	156

\* It necessary to secure sufficient space for maintenance more than the dimensions described in the product service.

# Installation

## Installation map (150 / 200 CMH)

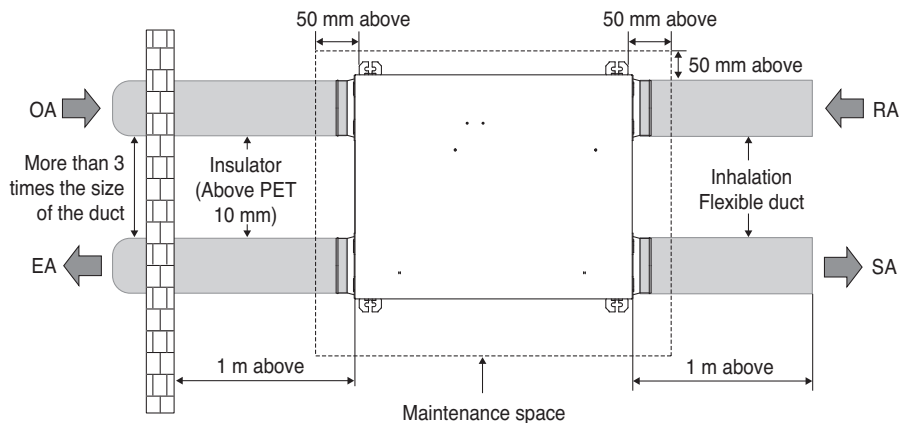

Duct slope: More than 1/30(wall side)  
obtaining of right distance  
(Preventing penetration of rain water)

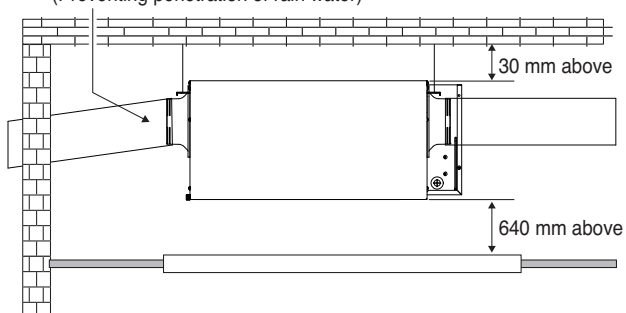

# Installation map (250 / 350 / 500 / 800 / 1 000 CMH)

## Plane figure

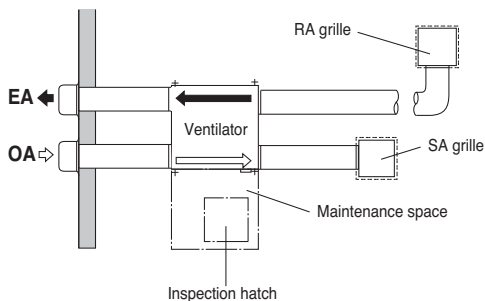

## Front view

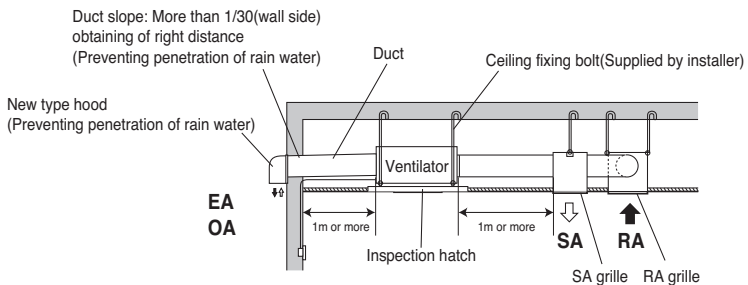

## Three dimension view

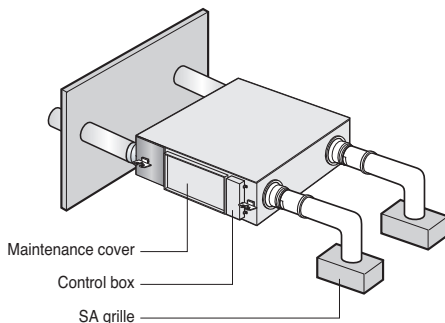

## Installation of maintenance cover

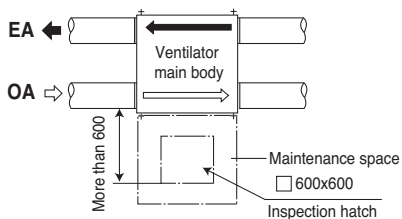



# Installation map (1 500 / 2 000 CMH)

## Plane figure

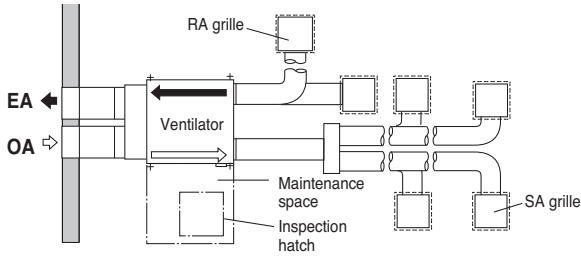

## Front view

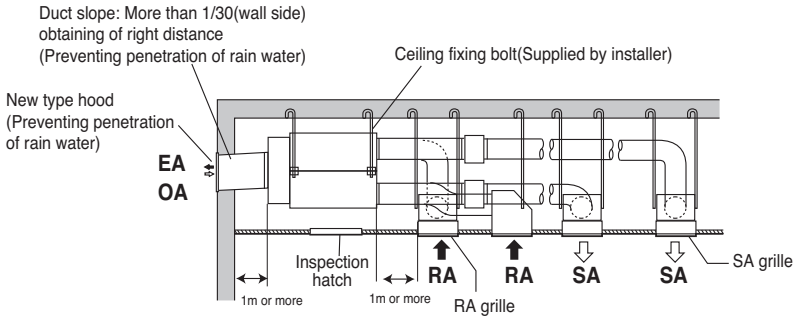

## Three dimension view

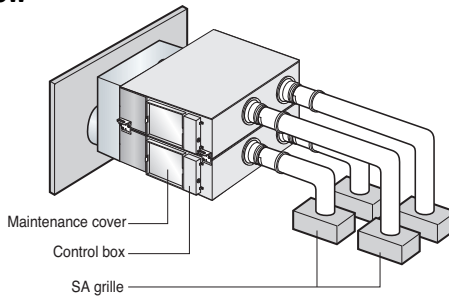

## Installation of maintenance cover

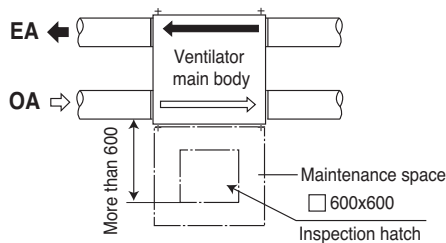

## Installation of main body

### Assembly of washer, nut

Tighten the common washer and nut (more than 21 mm for the outside diameter of M10, to the commercial ceiling fixing bolt (M10) as shown in the right figure.

- For the ceiling fixing bolt, perform work less than 50 mm under the ceiling fixing bracket.

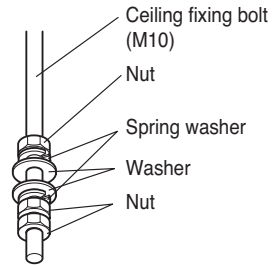

## Connection of duct

After securely connect the duct with the duct connection flange, wrap it with a commercial aluminium tape so that air cannot be leaked.

Adjust the duct from the ceiling so that no force is applied to the main body of the ventilation system.

Always use two ducts at the outdoor with the heat insulating material for prevention of dewing.

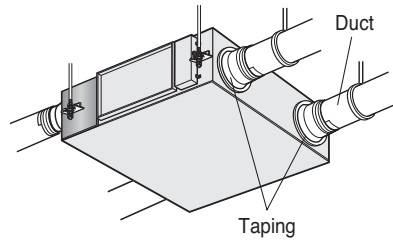

## ⚠ CAUTION

- Check that there are no foreign materials (paper, vinyl, etc) or cutoff powders in the duct before connecting the duct.
- Take care so that shock may not be applied to the damper plate within the main body when performing the duct connection work.
- It is recommended to perform adiabatic treatment even to the duct pipe at the indoor side where ambient temperature is expected higher than room temperature when the main body of the ventilation system for cooling in summer.
- Take care so that work may not be performed as in the left figure. Otherwise, it may cause reduction of air volume or abnormal noise.

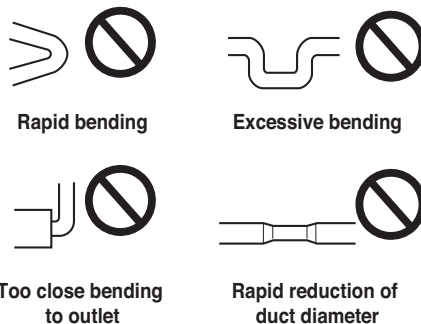
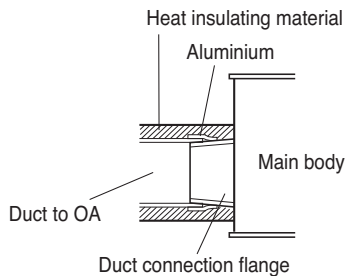

## ⚠ CAUTION

- In -10 °C below ambient temperature, when ventilation is installed the equivalent space in the outdoor and outdoor, It may cause condensation, you must install drainage facilities(drain pan) and MD(Motorized Damper) at SA/RA duct.

## Method to connect power cord

**Release two screws and then open the cover of the control box.**

- With reference to the below wiring diagram, accurately connect the main power cords into the terminal block.

Cover of control box

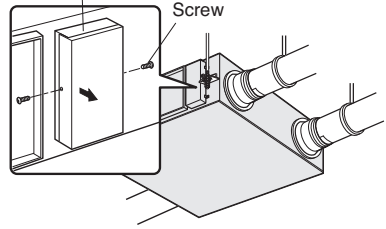

**After inserting the power cord into the bushing, fully insert it into the terminal block for connection.**

- Fix the power cords with the clamp.
- Make sure that the power cords may not be removed by pulling them.

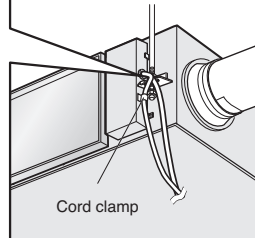
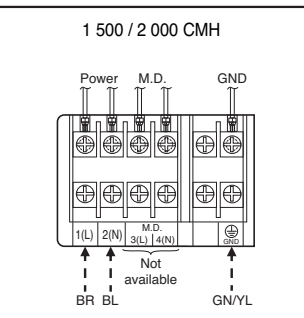
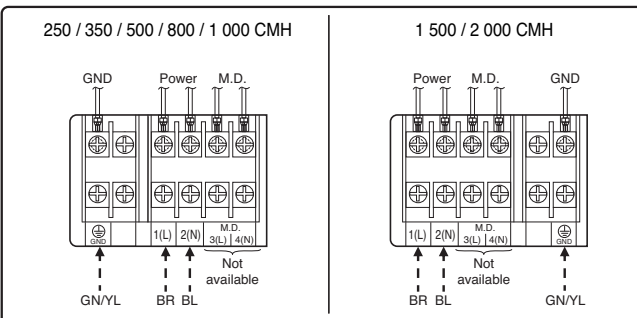
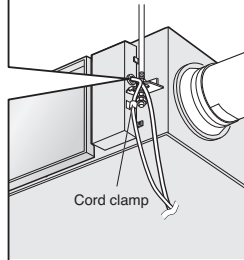
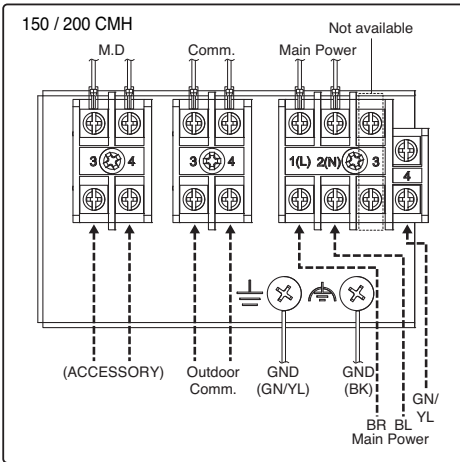

**⚠ CAUTION**

The power cord connected to the unit should be selected according to the following specifications.

**⚠ WARNING**

Indoor unit ground wires are required for preventing electrical shock accident during current leakage, Communication disorder by noise effect and motor current leakage (without connection to pipe).

**Wiring specifications**

Wiring specifications	Sheathed wire (should be complied with 60245 IEC 53 standard)
Size	150~800 CMH : 0.75 mm <sup>2</sup> / 1 000~2 000 CMH : 1 or 1.5 mm <sup>2</sup>
Length	MAX. 100 m
External contact specifications	Normally closed contact (Current tolerance 10 mA - 0.5 A)

**Precautions when laying power wiring**

Use round pressure terminals for connections to the power terminal block.

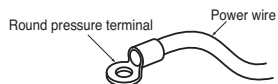

## How to connect remote controller(accessory)

Please connect indoor unit and remote controller using connection cable.

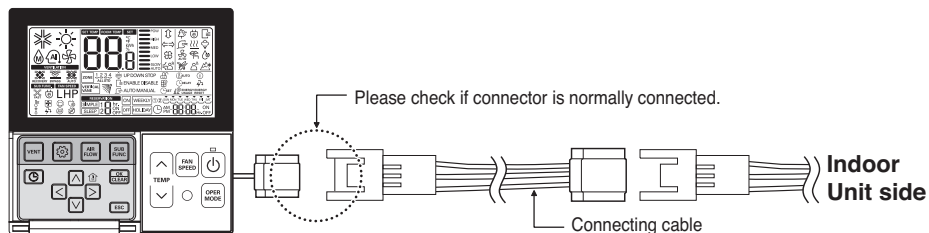

Please use extension cable if the distance between wired remote controller and indoor unit is more than 10 m.

### **⚠ CAUTION**

When installing the wired remote controller, do not bury it in the wall.

(It can cause damage in the temperature sensor.)

Do not install the cable to be 50 m or above.

(It can cause communication error.)

- When installing the extension cable, check the connecting direction of the connector of the remote controller side and the product side for correct installation.
- If you install the extension cable in the opposite direction, the connector will not be connected.
- Specification of extension cable: 2547 1007 22# 2 core 3 shield 5 or above.

## How to use the filter check alarm function by filter clogging (800/1000/1500/2000 CMH)

- To enable the filter check alarm function, you must set "test run" in the installer settings on the remote control.
- After the test run is finished, the product will turn off.
- During the test run, the remote control will not turn off the power.
- Noise caused by operation mode change during test run may occur, but this is not a product error.
- Check filter contamination before test run operation.
- Except for rated voltage(220~240 V), it can be detected incorrectly.
- It may be affected by the external environment, but this is not a product error.

### CAUTION

- If the test run function is not used, the filter check alarm function can not be used.
- After T.A.B and filter and PCB replacement, test run must be performed.

- Some categories of the menu may not be displayed according to the function of the product, or the menu name may be different.
- For more details, refer to the remote controller manual.

## Group control

**When installing more than 2 units of air conditioner to one wired remote controller, please connect as the right figure.**

- If it is not event communication indoor unit, set the unit as slave.
- Check for event communication through the product manual.

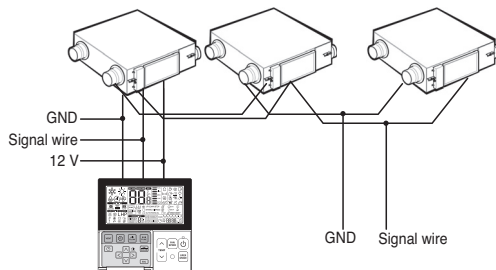

When controlling multiple indoor units with event communication function with one remote controller, you must change the master/slave setting from the indoor unit.

- Indoor units, the master/slave configuration of the product after completion of indoor unit power 'Off' and then 'On' the power after 1 minutes elapsed sign up.
- For ceiling type cassette and duct product group, change the switch setting of the indoor PCB.

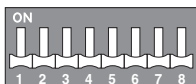

#1 switch Off: Master  
(Factory default setting)

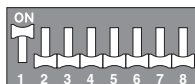

#1 switch On: Slave

- For wall-mount type and stand type product, change the master/slave setting with the wireless remote controller. (Refer to wireless remote controller manual for detail)
  - \* When installing 2 remote controllers to one indoor unit with event communication function, set the master/slave of the remote controller. (Refer to remote controller master/slave selection)
- When controlling the group, some functions excluding basic operation setting, fan level min/mid/max, remote controller lock setting and time setting may be limited.

**When installing more than 2 wired remote controllers to one air conditioner, please connect as the right picture.**

- When installing more than 2 units of wired remote controller to one air conditioner, set one wired remote controller as master and the others all as slaves, as shown in the right picture.
- You cannot control the group as shown in the right for some products.
- Refer to the product manual for more detail.

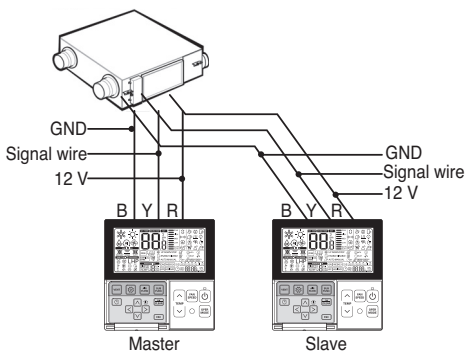

<When simultaneously connecting 2 sets of wired remote controller>

- When controlling in groups, set the master/slaver of the remote controller. Refer to Installer setting section on how to set master/slave for more detail.





## Installer setting - How to enter installer setting mode

### ⚠ CAUTION

Installer setting mode is to set the detail function of the remote controller.

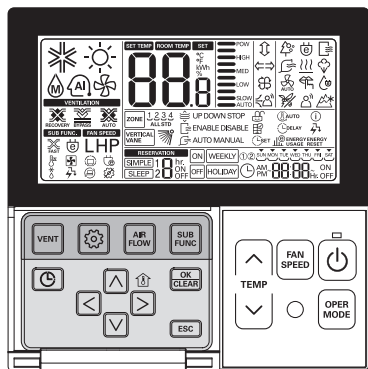
If the installer setting mode is not set correctly, it can cause problems to the product, user injury or property damage. This must be set by a certificated installer, and any installation or change that is carried out by a non-certificated person should be responsible for the results. In this case, free service cannot be provided.



- 1 If pressing  button long for 3 seconds, it enters into remote controller setter setup mode.  
- If pressing once shortly, it enters into user setup mode. Please press more than 3 seconds for sure.

- 2 When you enter the setting mode initially, Function code is displayed on the bottom of the LCD screen.

  
 Function code      Value

- Some categories of the menu may not be displayed according to the function of the product, or the menu name may be different.

## Accessory Model

- In the menu screen, press [**<**,**>**(left/right)] button to select the setting category, and press [**^**(up)] button for 3 seconds to enter the password input screen for the installer setting.
- Input the password and press [**OK**] button to move to the installer setting list.

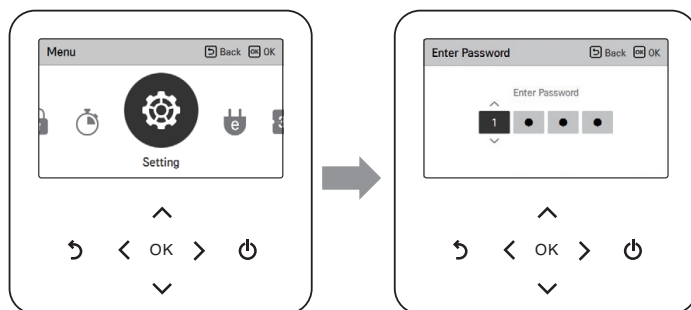

### \* Installer setting password

Main screen → menu → setting → service → RMC version information → SW Version

Example) SW version : 1.00.1 a

In the above case, the password is 1001.

- Some categories of the menu may not be displayed according to the function of the product, or the menu name may be different.
- For more details, refer to the remote controller manual.

## &lt;Installer setting code table&gt;

## General ventilation product

No.	Function	Code	Value															
1	Test run	01	01 : Test run setup															
2	Address setting	02	00~FF : Address of central control															
3	SA(Supply Air) ESP	03	<table style="border: none;"> <tr> <td style="text-align: left;">&lt;ESP level&gt;</td> <td style="text-align: left;">&lt;ESP value&gt;</td> <td style="text-align: left;">&lt;Example&gt;</td> </tr> <tr> <td>01 : Low</td> <td>0~255</td> <td>0301 15<sub>s</sub></td> </tr> <tr> <td>02 : High</td> <td></td> <td style="text-align: center;"> <div style="display: flex; justify-content: space-around; width: 100%;"> <div style="text-align: center;">0301</div> <div style="text-align: center;">15<sub>s</sub></div> </div> </td> </tr> <tr> <td>03 : Super high</td> <td></td> <td style="text-align: center;"> <div style="display: flex; justify-content: space-around; width: 100%;"> <div style="text-align: center;">↓</div> <div style="text-align: center;">↓</div> <div style="text-align: center;">↓</div> </div> </td> </tr> <tr> <td></td> <td></td> <td style="text-align: center;"> <div style="display: flex; justify-content: space-around; width: 100%;"> <div style="text-align: center;">Function Code</div> <div style="text-align: center;">ESP step</div> <div style="text-align: center;">ESP value</div> </div> </td> </tr> </table>	<ESP level>	<ESP value>	<Example>	01 : Low	0~255	0301 15 <sub>s</sub>	02 : High		<div style="display: flex; justify-content: space-around; width: 100%;"> <div style="text-align: center;">0301</div> <div style="text-align: center;">15<sub>s</sub></div> </div>	03 : Super high		<div style="display: flex; justify-content: space-around; width: 100%;"> <div style="text-align: center;">↓</div> <div style="text-align: center;">↓</div> <div style="text-align: center;">↓</div> </div>			<div style="display: flex; justify-content: space-around; width: 100%;"> <div style="text-align: center;">Function Code</div> <div style="text-align: center;">ESP step</div> <div style="text-align: center;">ESP value</div> </div>
<ESP level>	<ESP value>	<Example>																
01 : Low	0~255	0301 15 <sub>s</sub>																
02 : High		<div style="display: flex; justify-content: space-around; width: 100%;"> <div style="text-align: center;">0301</div> <div style="text-align: center;">15<sub>s</sub></div> </div>																
03 : Super high		<div style="display: flex; justify-content: space-around; width: 100%;"> <div style="text-align: center;">↓</div> <div style="text-align: center;">↓</div> <div style="text-align: center;">↓</div> </div>																
		<div style="display: flex; justify-content: space-around; width: 100%;"> <div style="text-align: center;">Function Code</div> <div style="text-align: center;">ESP step</div> <div style="text-align: center;">ESP value</div> </div>																
4	EA(Exhaust Air) ESP	04																
5	Product direction	05	01 : Normal 02 : Opposite															
6	Quick refresh priority	06	01 : Supply air first 02 : Exhaust air first															
7	Master setting	07	00 : Slave 01 : Master															
8	Dry contact	09	00 : Auto-off 01 : Auto-on															
9	Release of 3 minute delay	10	01 : Set															
10	Zone state test run	11	01 : Variable 02 : Fixed															

\* Some contents may not be displayed depending on the product function

# Test running

## Method to operate and select air volume - Interlinked operation with ventilation



It is used when air conditioner is interlinked with ventilation product.

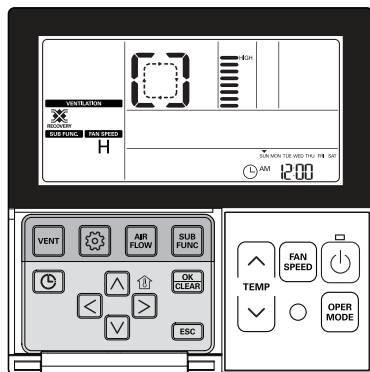

It is a function that cools and refreshes indoor air using the ventilation product at the same time operating the air conditioning function.





### Ventilation interlinked operation

- 1** Press  button on the remote controller control panel. - It is only used when air conditioner and general ventilation is interlinked. ('Interlinked operation' displayed on the remote controller display)

- 2** Pressing 'Start/Stop' button at ventilation mode will start ventilation.
- 3** Pressing  button will change the ventilation operation mode. Pressing operation selection button will change the mode in the order of 'heat exchange → normal → automatic'  
 ※ It only displays on the remote controller display when it is in ventilation mode, and it displays the desired temperature when it returns to air condition mode.



- 4** Pressing  button in general ventilation mode will change airflow speed. Pressing airflow speed button will change the mode in the order of 'weak → strong → very strong'.  
 If CO<sub>2</sub> sensor is installed, it can select from 'weak → strong → very strong → automatic'.

- 5** Changing back to air conditioner mode

  - 1) Automatic conversion : when no button is pressed for 15 seconds or longer, it automatically converts back to air conditioner mode.
  - 2) Manual conversion : pressing  button in ventilation mode will manually convert.

Ventilation product user manual - Single operation with general ventilation

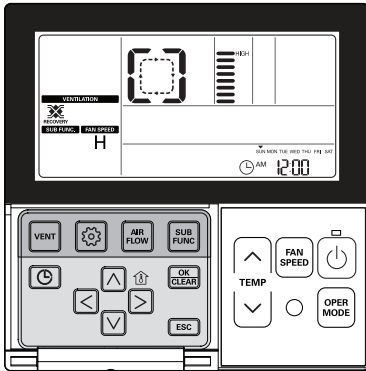
This function is to circulate the air in the room using a general ventilator.



### Single Operation with General Ventilation

- 1 Press button on the remote controller.
- 2 Press button to convert the ventilation mode.
 

Vent mode	Remote controller display window	Description
Heat exchange		The fresh air entering the room is heated or cooled by the air leaving the room. This mode is used when pre-heating or pre-cooling improves comfort and reduces energy consumption.
Normal		The fresh air by-passes the heat exchanger and enters the room at outdoor temperature.
Auto		The system selects Heat exchange or Normal automatically after comparing indoor and outdoor temperatures.

In the case of heat exchange mode is shown below.

[ → [ → [ → [ → ] → ] → ] → ... ]
- 3 Press button in the Vent mode to change the fan speed.
  - Each time you press the button the fan speed is selected in the order of low → high → power.
  - If a CO<sub>2</sub> sensor is installed, you can select the fan speed in the order of low → high → power → auto.

## In case of finding a problem at a test running

Symptom	Check item	Counter-measure
The product doesn't work	Is power not supplied?	Supply power
The product doesn't work through you press the 'On' switch	Is air filter, total heat exchanger clogged severely?	Follow cleaning and changing method.
	Are the PCB and remote controller rightly connected?	Connect rightly PCB and remote controller.
The fan doesn't run	Is the outdoor temperature the limit temperature? (Less than -10 °C (14 °F), more than 45 °C (113 °F))	Switch on Option No. 5. Repower the product and check whether it works or not. Switch off Option No. 5. and repower the product once again.
Even though you push the button of remote controller, any function doesn't work.	Is the icon "  " displaying on remote controller?	It's child lock mode. Refer to remote controller.

## Airborne noise emission

The A-weighted sound pressure emitted by this product is below 70 dB.

\*\* The noise level can vary depending on the site.

The figures quoted are emission level and are not necessarily safe working levels. Whilst there is a correlation between the emission and exposure levels, this cannot be used reliably to determine whether or not further precautions are required. Factor that influence the actual level of exposure of the workforce include the characteristics of the work room and the other sources of noise, i.e. the number of equipment and other adjacent processes and the length of time for which an operator exposed to the noise. Also, the permissible exposure level can vary from country to country. This information, however, will enable the user of the equipment to make a better evaluation of the hazard and risk.



LG Electronics Inc. Single Point of Contact (EU/UK) :  
LG Electronics European Shared Service Center B.V.  
Krijgsman 1, 1186 DM Amstelveen, The Netherlands

Manufacturer :  
LG Electronics Inc.  
84, Wanam-ro, Seongsan-gu, Changwon-si, Gyeongsangnam-do, KOREA

UK Importer :  
LG Electronics U.K. Ltd,  
Velocity 2, Brooklands Drive, Weybridge, KT13 0SL

Eco design requirement

- The information for Eco design is available on the following free access website.  
<https://www.lg.com/global/support/cedoc/cedoc>