



Visit us at : <http://www.lgservice.com>

LG

ENGLISH

LG

# Air conditioner Base controller

## *Owner's & Installation Manual*

**Model: PQCSA001T0**

### IMPORTANT

- Please read this Owner's & Installation Manual carefully and thoroughly before installing and operating your Base Station air conditioner.
- Please retain this Installation Manual for future reference after reading it thoroughly.



# Contents

■ <b>Safety Precautions</b> .....	3
■ <b>Functions and names</b> .....	6
Overview .....	6
Main functions.....	6
General specification .....	7
Components .....	8
Names for each part.....	9
■ <b>Wiring</b> .....	10
Diagram for the base station controller .....	10
How to connect the base station controller.....	11
How to connect the base station controller (2) .....	13
■ <b>Product setting</b> .....	14
Setting the indoor unit address .....	14
Setting the base station controller.....	16
Operating the base station controller .....	20
Using the unit.....	22
Errors from the base station controller.....	23



# Safety Precautions

To prevent injury to the user or other people and property damage, the following instructions must be followed.

■ Incorrect operation due to ignoring instruction will cause harm or damage. The seriousness is classified by the following indications.

 <b>WARNING</b>	This symbol indicates the possibility of death or serious injury.
 <b>CAUTION</b>	This symbol indicates the possibility of injury or damage.

■ Meanings of symbols used in this manual are as shown below.

	<b>Be sure not to do.</b>
	<b>Be sure to follow the instruction.</b>

## **WARNING**

### ■ When installing

**Call the service center or the professional installation agency for installing the product.**

- It may cause fire, electric shock, explosion or injury.

**Call the service center or the professional installation agency for reinstalling the product.**

- It may cause fire, electric shock, explosion or injury.

**Use the standard parts.**

- It may cause fire, electric shock, explosion, injury or malfunction.

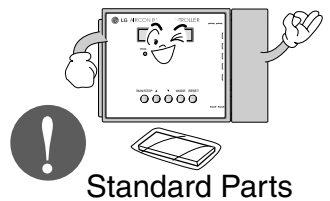
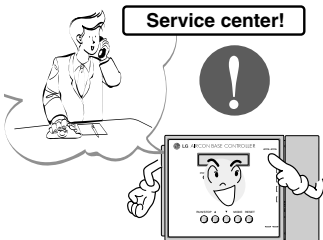

**Keep or use inflammable gas or material near the product.**

- It may cause fire or the malfunction of the product.

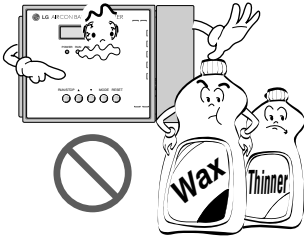

**Do not disassemble, repair or modify the product at random.**

- It may cause fire or electric shock.

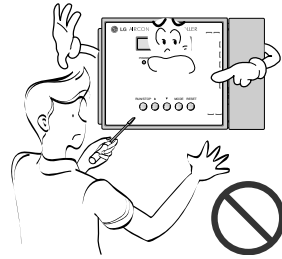

**Do not install the product at the place exposed to rain.**

- It may cause malfunction.

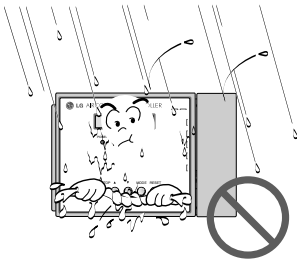

**Do not install the product at the wet place.**

- It may cause malfunction.

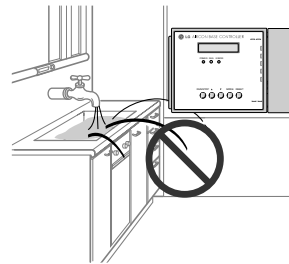

**■ When operating**

**Do not change or extend the power cord at random.**

- It may cause fire or electric shock.



**Do not place any heating source near the product.**

- It may cause fire.

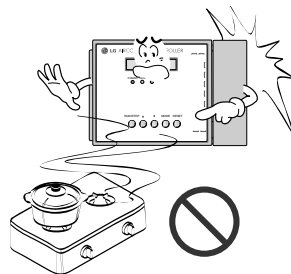

**Do not use any heating source near the power cord.**

- It may cause fire or electric shock.

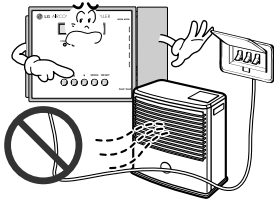

**Do not put any heavy object on the power cord.**

- It may cause fire or electric shock.

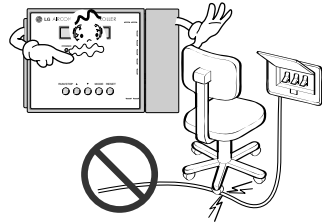

**Do not put any heavy object on the product.**

- It may cause malfunction.

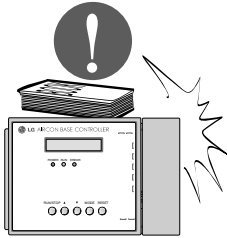

**If the product is submerged, call the service center or the professional installation agency.**

- It may cause fire or electric shock.

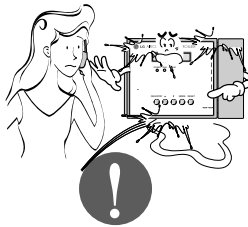

**Do not shock the product.**

- It may cause malfunction.

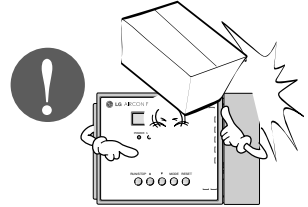

## CAUTION

### ■ When operating

**Do not clean with strong detergent such as solvent, but with soft cloth.**

- It may cause fire or deform the product.

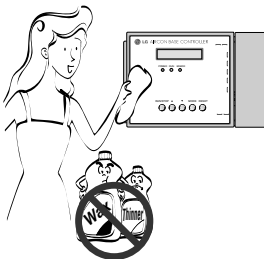

**When unplugging the power cord, take the head of the cord to pull out and do not touch the cord with wet hands.**

- It may cause fire or electric shock.



# Functions and names

## Overview

It is the controller for the 24-hour cooling operation for the base station or the computer center, which controls two air conditioners to alternately operate. It generates the contact signal to the outside when it detects the water leakage/fire or the error of the air conditioner.

## Main functions

### 1. Recording the Run/Stop condition

It operates at the same condition as before the power failure by recording the condition at the time of the power failure.

### 2. Auto reset

When the controller of the base station stops or fails by noise, surge voltage, lightning or voltage drop, the Micom is automatically reset and normally operated.

### 3. Detecting temperature/humidity

It monitors and controls the current temperature/humidity within the unattended base station.

### 4. Monitoring the operating state and alarming the product error

It monitors the operating state of the air conditioner, displays the error message when any error is occurred from the indoor unit, and notifies the base station of the product error.

### 5. Detecting the alarm condition

It monitors any abnormal condition such as water leakage and fire within the base station and controls the operation of the air conditioner.

- When fire is occurred, it stops the air conditioner and generates the error message and the fire alarm.
- When water leakage is occurred, it generates the error message and the water leakage alarm.

### 6. Remote control (optional)

Optional, offered by the additional protocol processing when necessary.

- \* The running condition of the machine at the base station can be monitored or controlled by the RS 485 communication.

### 7. Rotary operation

Indoor unit #1 and Indoor unit #2 are alternatively operated automatically according to the preset time, and when the running indoor unit of the air conditioner fails, the other indoor unit is operated instead of it.

### 8. Protection from power failure or frequent running/stopping of the air conditioner

When the instant power failure is occurred during the operation of the air conditioner, all conditions for protecting the machine are protected to operate by the self system of the air conditioner.

## 9. High-temperature alarm for the inside of the base station

When the internal temperature of the base station is 30°C or higher, it generates the error message and the high temperature error alarm.

- When fire is occurred, it stops the air conditioner and generates the error message and the fire alarm.
- When water leakage is occurred, it generates the error message and the water leakage alarm.

## 10. Automatic switching for the abnormal air conditioner

When the running indoor unit fails, the redundant indoor unit is run instead of it.

(Ex: when the indoor unit of the air conditioner fails, the secondary indoor unit is automatically run.)

## General specification

Item	Specification	Remarks
<b>Power</b>	100~250V AC 50/60Hz (DC12V 1.5A Adaptor,6708AQ0001A)	Dedicated Controller
<b>Operating temperature</b>	-10°C~60°C	for LCD
<b>Set temperature</b>	7°C~99°C(sensed temperature 0.5~5°C)	
<b>Communication distance</b>	200M (controller - Primary air conditioner) Total 400M	
<b>Communication type</b>	Type :RS-485 BPS :4800	Communication Spec between Controller & Product.
<b>Installed wire</b>	0.75 mm <sup>2</sup> 2P shield	Optional by Installer/ Builder
<b>PI485</b>	PMNFP14A0(multi / Multi V / Communication Model) PSNFP14A0(None-Communication RAC Product) PHNFP14A0(None-Communication CAC Product)	Separately purchased
<b>Input</b>	5 points fire sensor, temperature sensor, humidity sensor, water leakage sensor, external temperature (optional)	External temperature is Option for Update (can't use now)
<b>Output</b>	5 points Product error, high temperature error, water leakage error, fire error, ventilating fan (optional)	Ventilating fan is Option for Update (can't use now)
<b>Temperature/ Humidity sensor</b>	Standard specification - temperature 7~100°C Humidity 20~80% - temperature/humidity sensor in common	Dedicated Controller
<b>Water leakage sensor Fire sensor</b>	Optional by the builder	
<b>Applicable product</b>	All LGAP applied products	

## Components

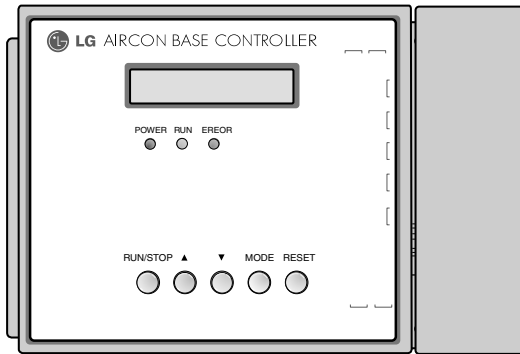

Front panel of controller at the base station

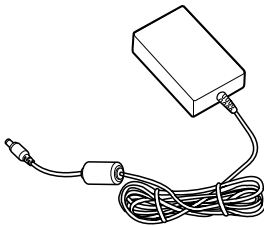

**Adaptor for Power supply**  
Input: 100~240V  
AC 50/60Hz 1.5A  
Output: DC 12V  
3.33A, 40W MAX

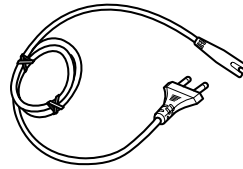

**Power Cord**  
International Standard  
IEC320 C14 Type

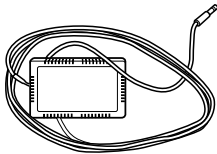

Temperature/Humidity sensor



Setting the indoor unit address

### Caution: Using the standardized part



We are not responsible for any problem caused by using the adaptor other than the standardized one offered by us, so using any non-standard part should be prohibited. You can consult the LG System Air Conditioner Support Division about the applicable product.

### Notice : In Australia, purchase the power code

In Australia, the power code from local area.  
The power code is not included in the package



## Names for each part

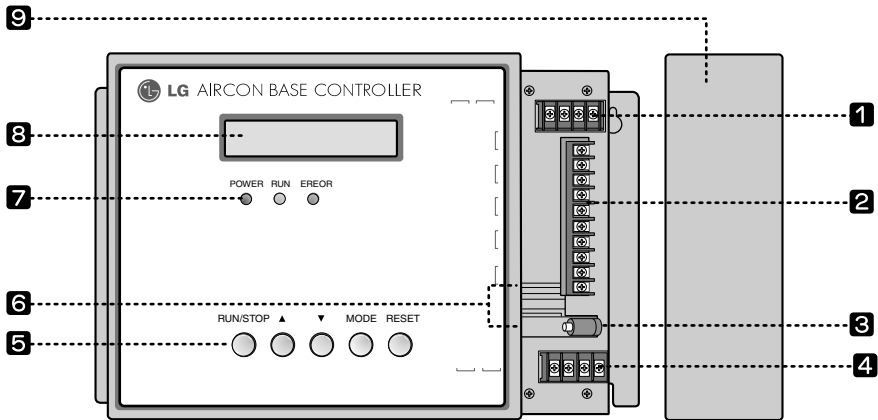

### 1. RS 485 communication

AIRCON\_A: Air conditioner connector A(+)  
 AIRCON\_B: Air conditioner connector B(-)  
 CENTER\_A: Optional  
 CENTER\_B: Optional

### 5. Operating button

RUN/STOP: Run/Stop  
 ▲ : Up ▼: Down  
 MODE: Initial setting  
 RESET: Initializing the product

### 2. Output: Error signal

- Water leakage error . Temperature error
- Ventilating error . Air conditioner error
- Fire error

### 6. Temperature/Humidity sensor

TEMP•HUM SENSOR: Internal temperature/humidity sensor input  
 EXT\_TEMP SENSOR: External temperature sensor input

### 3. Power: Adaptor connection

(Input power DC 12V, input current 1.5A)

### 7. LED: Displaying POWER, RUN, ERROR

### 4. External sensor (optional)

FIRE SENSOR\_G/N: External fire sensor input  
 WATER SENSOR\_G/N: External humidity sensor input

### 8. LCD: Operating condition

### 9. Service cover: Terminal & wiring protection cover

# Wiring

## Diagram for the base station controller

The base station controller is connected to one main indoor unit and one auxiliary indoor unit.

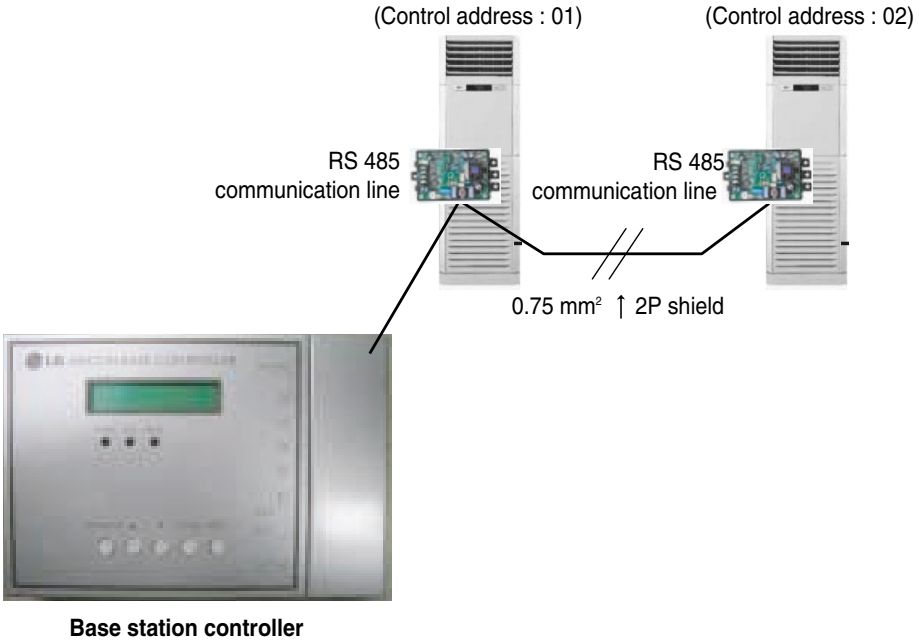

Enter the central control addresses "01" and "02" into each indoor unit by the wired/wireless remote controller.

- Purchase the PI -485 separately.
- Specification of RS485 communication line: Use the 0.75mm<sup>2</sup> 2P shield wire

## How to connect the base station controller

- Refer the wiring diagram and make the connections accordingly

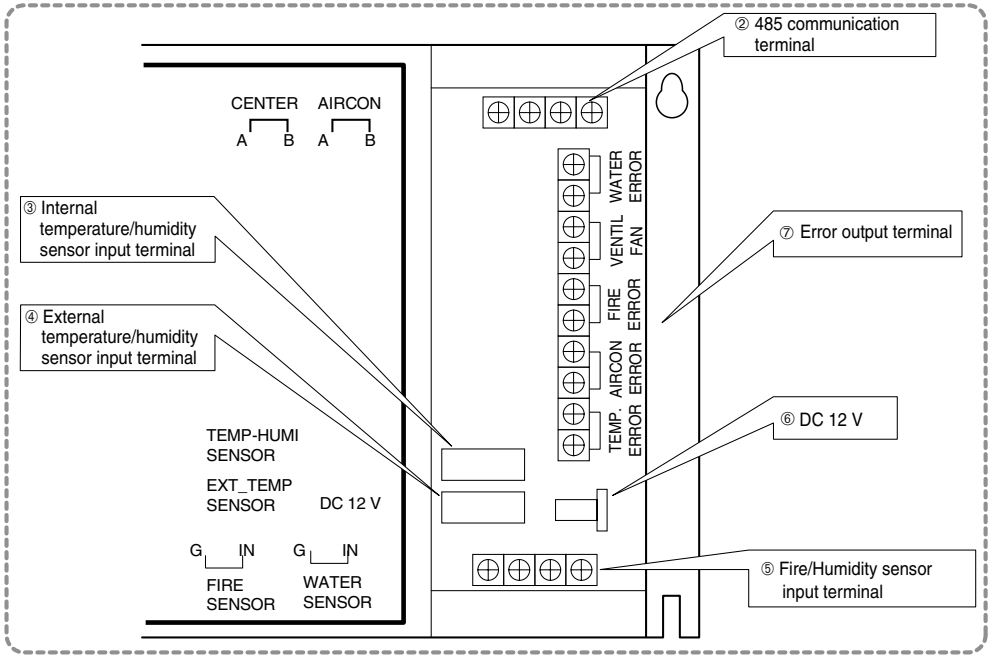
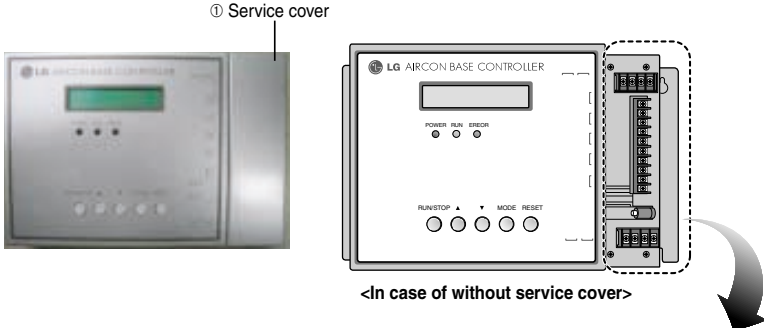

**Connect the PI 485 communication line BUS\_A, BUS\_B.**

### [Steps to connect]

- ① Remove the right service cover from the main body of the base station controller
- ② Insert the RS-485 communication line connecting to the PI 485 through the left hole of the service cover and connect it to the air conditioner A and B.  
(\* **Note:** \* Because the PI 485 communication line A and B have polarity, check the following table)

Base station controller	PI 485 communication terminal
Air conditioner A terminal	BUS_A
Air conditioner B terminal	BUS_B

- ③ Insert the internal temperature/humidity sensor line through the left hole of the service cover and connect it to the CN\_TEMP\_HUMI connector.
- ④ The external temperature/humidity sensor connector is for the additional extension, which is not connected (optional).
- ⑤ Insert the fire sensor line and the water leakage sensor line through the left hole of the service cover and connect them to FIRE SENSOR and WATER SENSOR terminals respectively.  
(\* **Note:** Check the input and the grounding line of each terminal)
- ⑥ Insert the DC 12V adaptor line through the left hole of the service cover and connect it to CN\_POWER connector.
- ⑦ Insert the error output line for monitoring through the left hole of the service cover and then connect it.  
(\* **Note:** each output signal is generated as relay contact signal. See 'Output definition for the alarm condition' for the contact type.)
- ⑧ When all connections are finished, install the service cover.

## How to connect the base station controller (2)

### Connecting the PI 485 communication line

ENGLISH

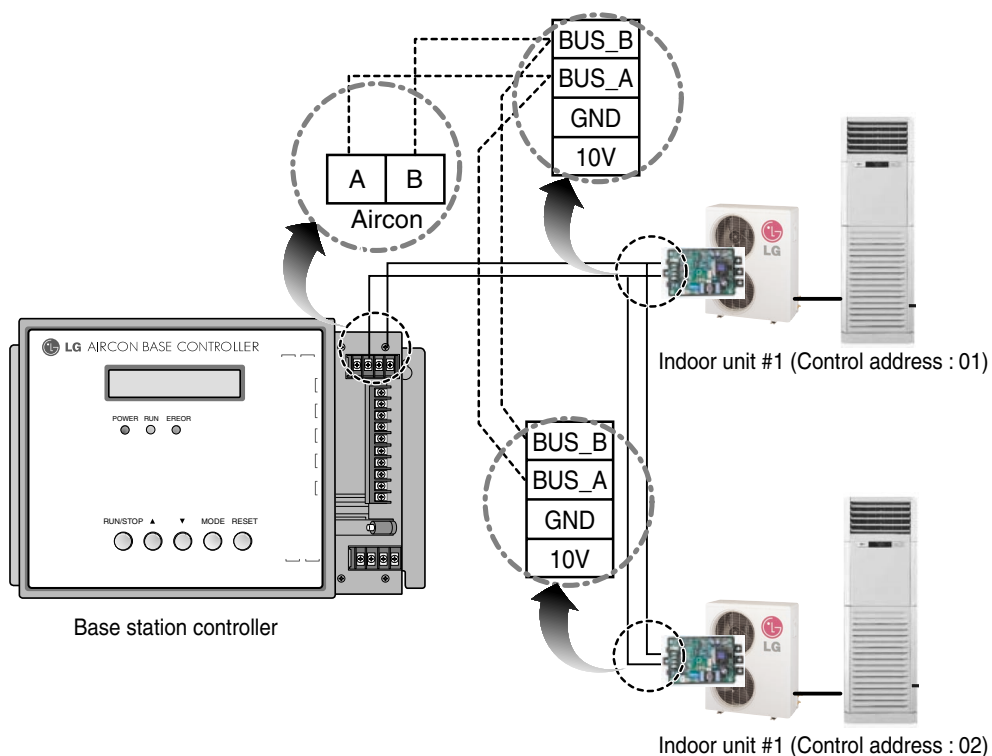

### [Steps to connect]

**\*Note:** See the PI 485 manual for the internal setting.

**\*Note:** Because the RS485 communication line connecting to the PI 485 has polarity, check A and B. PI485

# Product setting

## Setting the indoor unit address

### ■ When using the wired remote controller

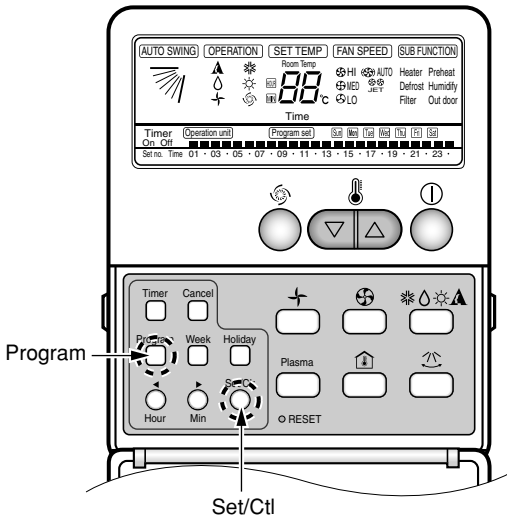

1. Press and hold both the Program button and the Set/Ctl button for 3 seconds.
2. Use the Temperature control key to set the indoor unit address.

Ex)

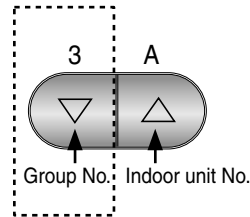

3. Press and hold both the Program button and the Set/Ctl button for 3 seconds to complete the address setting.

\* Because two indoor units of the base station controller are connected, the group No. is '01' and the indoor unit No. is '1' or '2'.

Ex) Setting the indoor unit address: '01', '02'

## ■ Using Wireless Remote Controller

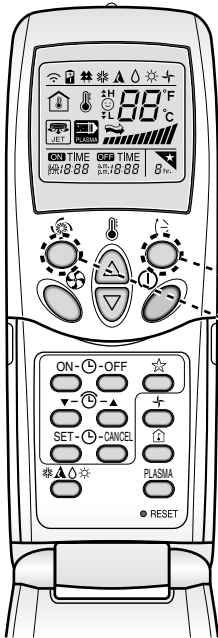

### 1. Address setting mode

- 1) Keep pressing upper left side key continuously and press RESET button once. Now the system is ready for address setting.
- 2) Set the Indoor unit address using the temperature controller buttons.  
Allowed Range : 00-FF

Ex)

Address  
check

3



← Group No.

A

← Indoor unit No.

Address  
setting

- 3) After setting the address, press ON/OFF key once towards Indoor unit.
- 4) The Indoor unit shows the set address and it means completion of address setting process. (The address displaying time and its way can depend upon the type of Indoor unit )

### 2. Address check mode

- 1) Keep pressing upper right side key continuously and press RESET button once. Now the system is ready for address checking.
- 2) Press ON/OFF key once toward the Indoor unit which shows set address on the display. (The address displaying time and its way depends upon the type of Indoor unit )
- 3) Reset the remote controller to use it for normal operation mode.

※ Some remote controllers may not support above functions according to the production date of wired/wireless remote controllers. As it has no concern with customer's use, use the remote controller available for the address setting during installation.

## Setting the base station controller

### Initial screen

#### Power-on screen

Base Station Control  
Version XXXXX



#### Ready-to-run screen

Stop Set Temp 23.0°C  
Real Temp 20.5°C

### Function setting

- Press and hold the Mode button to switch to the system setting screen.
- The operation mode can be set by Up(▲) or Down(▼) button, and press the Mode button to switch to the next setting.
- When you press and hold the button for 3 seconds or do not press the Mode button for 10 seconds, it stores the change and switches to the initial screen.
- Steps to switch the function setting screen

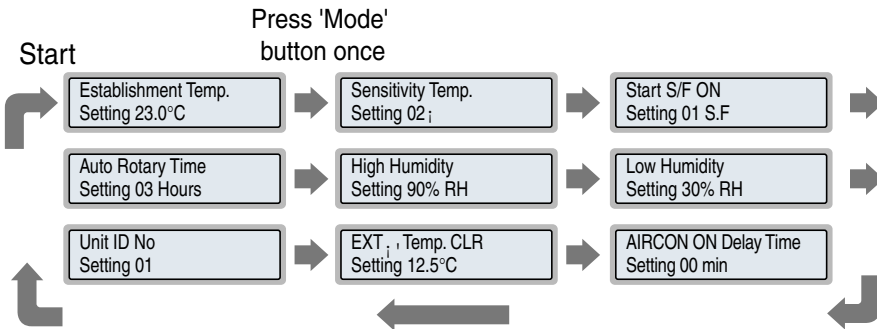

### 1 Establishment temperature setting

- Press "Mode" button once to display the setting temperature on the LCD.

Establishment Temp.  
Setting 23.0 °C

#### [Setting temperature]

- ↳ The default value is 23.0°C.
- ↳ The setting range of the establishment temperature is 7.0°C~99.0°C.

- Press Up(▲) or Down(▼) button to set the desired indoor temperature.
- The establishment temperature is set by 0.1°C.



## 2 Sensitivity temperature setting

- The number of air conditioners to run is determined according to the sensed temperature (difference between indoor and outdoor).
- Press "Mode" button once to display the sensitivity temperature on the LCD.
- If the difference between the indoor temperature and the setting temperature is higher than the 2time of sensitivity temperature, two indoor units are run, but if the difference is Higher than the sensitivity temperature range, one indoor unit is alternately run during the shift time. If there is no difference, the indoor unit is not run.

Sensitivity Temp.  
Setting 0.5 °C

### [Setting temperature]

- ↳ The default value is 0.5°C.
- ↳ The desired range of the sensitivity temperature is 0.5°C~5.0°C

- Press Up(▲) or Down(▼) button to set the desired temperature.
- The Sensitivity temperature is set by 0.5°C
  - ※ We recommend that setting the sensitivity temperature by 1.0°C level.

## 3 Start S/F ON setting

- Press "Mode" button once to display the Start S/F ON setting on the LCD.
- Select the indoor unit initially run at the "RUN" operation after setting the system.

Start S/F ON  
Setting 01 S.F

### [Indoor unit to set]

- ↳ The default value is 01 S.F.
- ↳ The setting range is 01~02 S.F.

- Press Up(▲) or Down(▼) button to set the desired indoor unit initially run.
- The setting range is set by 1.

## 4 Auto Rotary time setting

- Press "Mode" button once to display the Auto Rotary time setting on the LCD.
- Each indoor unit is alternately run after running during the set time.

Auto Rotary Time  
Setting 03 Hours

### [Time to set]

- ↳ The default value is 03 hours.
- ↳ The setting range is 01~24 hours.

- Press Up(▲) or Down(▼) button to set the desired rotary running time.
- The setting range is set by 1 hour.

### 5 High humidity setting

- Press "Mode" button once to display the High humidity setting on the LCD.



High Humidity  
Setting 90 % RH

#### [High humidity to set]

- ↳ The default value is 90% RH.
- ↳ The setting range is 60-95 RH.

- Press Up(▲) or Down(▼) button to set the desired setting.
- The setting range is set by 1% RH.

### 6 Low humidity setting

- Press "Mode" button once to display the Low humidity setting on the LCD.

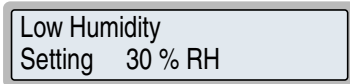

Low Humidity  
Setting 30 % RH

#### [Low humidity to set]

- ↳ The default value is 30% RH.
- ↳ The setting range is 5-50 RH.

- Press Up(▲) or Down(▼) button to set the desired setting.
- The setting range is set by 1% RH.

### 7 Unit ID No. setting

- It sets the ID of the said base station controller.
- Press "Mode" button once to display the Unit ID No. setting on the LCD.

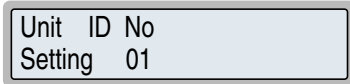

Unit ID No  
Setting 01

#### [Select the unit number]

- ↳ The default value is 01.
- ↳ The setting range is 01-65.

- Press Up(▲) or Down(▼) button to set the desired setting.
- The setting range is set by 1.
  - ※ This function is for communicating with the central control center, which is not used currently.

### 8 External temperature setting (controlling the ventilating fan)

- Press "Mode" button once to display the EXT\_Temp. CLR setting on the LCD.
- It makes the indoor cooling possible by ventilating when the external temperature is low. (Indoor cooling in winter)

EXT\_Temp. CLR  
Setting 12.5°C

#### [External temperature setting]

- ↳ The default value is CLR.
- ↳ The setting range is 0.0°C~30.0°C.

- Press Up(▲) or Down(▼) button to set the desired setting.
- The setting range is set by 0.1°C.
  - ※ This function is optional, which is not used currently.

### 9 AIRCON ON Delay Time Setting

- It sets the running delay time. (setting not recommended)
- **\*Note:** It is the function for the additional extension, so do not set it separately.

AIRCON ON Delay Time  
Setting 00 min

#### [Air conditioner delay time]

- ↳ The default value is 00 min.
- ↳ The setting range is 00 min ~ 05 min.

- Press Up(▲) or Down(▼) button to set the desired time.
- The setting range is set by 1 minute.
  - ※ Even while the error message is displayed, if you press and hold the Mode button for 3 seconds, it is possible to set the product operation.
  - ※ When the error signal is received from the indoor unit of the air conditioner during the mode setting, the mode setting is continued, the received error signal is stored, and when setting the mode is completed, the error message is displayed on the LCD.

## Operating the base station controller

### ■ Setting the running mode, 3.5RT and 5.0RT running mode

- It is the run setting mode due to the added operation mode of LG Telecom.
- There are three setting modes such as normal auto rotary, 3.5RT and 5.0RT operation.
- Press "Mode" button (9 times at the initial setting mode) to display "MODE SELECT" on the LCD.
- Press Up(▲) or Down(▼) button to set the desired setting.  
It is set by the order of Auto Rotary -> 3.5RT -> 5.0Rt -> Auto Rotary.

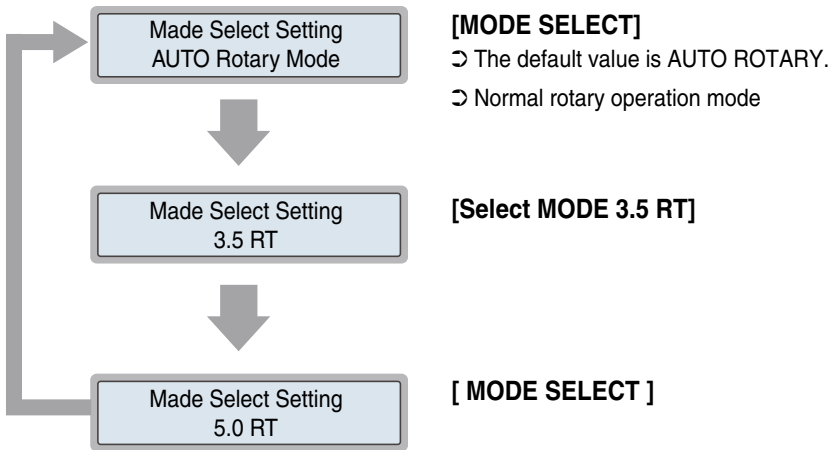

### ■ Air Conditioner (#1 and #2) OnTime setting

- Set the air conditioner OnTime only at 3.5 RT and 5.0 RT from the MODE SELECT Setting.  
Press Up(▲) or Down(▼) button to set the desired setting.  
It is set by 1 minute. (The setting range is 10~300 minutes.)

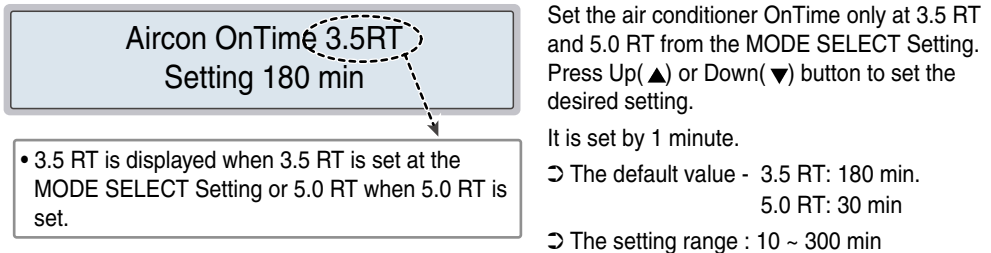

Aircon OffTime **3.5RT**  
Setting 015 min

- 3.5 RT is displayed when RT-3.5 is set at the MODE SELECT Setting or 5.0 RT when RT-5.0 is set.

It is the off time after the running time is completed.

The minimum setting is 4 minutes.

▷ The default value - 3.5 RT: 15 min.

5.0 RT: 5 min

(The off time is not permitted at the 5.0 RT mode)

▷ The setting range : 4 ~ 180 min

\* The explanation for the RT-3.5 and RT-5.0 operation at the time of the MODE SELECT setting.

#### A. Operation when 3.5 RT is selected

- On at the time of the initial running on, the air conditioner #2 is run off at the middle of the 2nd running on time of the air conditioner #1, and after this, the air conditioner #1 and #2 are simultaneously run for 50% by running according to the setting time.

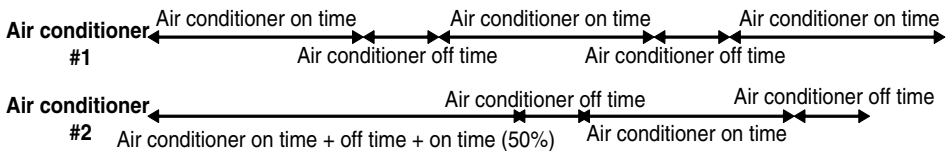

#### B. Operation when 5.0 RT is selected

- It starts the operation at 20~28°C when the running starts. The operation is done according to the following time chart.

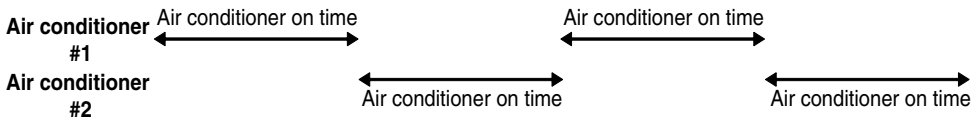

### ⚠ Caution

1. If it comes lower than the setting temperature, both the air conditioner #1 and #2 are stopped.
2. If it comes higher than 28°C, the program according to the timed running (3.5 RT or 5.0 RT) is terminated and both the air conditioner #1 and #2 are run.
3. After this, if it drops to 25°C, the running air conditioner #1 and #2 are stopped, and the previous normal timed running (3.5 RT or 5.0 RT) resumes.
4. The normal running range is operated with 20~25°C and if it comes lower than 20°C, running is stopped, and if it comes to 20°C again, the previous normal timed running (3.5 RT or 5.0 RT) resumes.

## Using the unit

### ■ Running the base station controller

Press "RUN/STOP" once to run the waiting indoor unit at the LCD.

Stopped unit screen

Stop Set Temp 20.0 °C  
Real Temp 22.5 °C



Running unit screen

RUN Set Temp 20.0 °C  
01 Real Temp 22.5 °C

- ※ The running indoor unit and the number of units depend on the initial setting value. (See the unit setting)
- ※ The actual indoor unit is run cooling 18°C, Strong wind or Auto wind direction.

### ■ Stopping the base station controller

Press "RUN/STOP" once to stop the running indoor unit at the LCD.

Running unit screen

RUN Set Temp 20.0 °C  
01 Real Temp 22.5 °C



Stopped unit screen

STOP Set Temp 20.0 °C  
Real Temp 22.5 °C

### ■ RESET

If the base station controller stops or abnormally stops, press "RESET" once to forcefully initialize the unit.

- ※ When you press "RESET" button, the currently running indoor unit is stopped.

Stop Set Temp 20.0 °C  
Real Temp 22.5 °C

## Errors from the base station controller

- When the cause of the error is solved, all operations are automatically resumed.
- The error code of 1 and 2 shows the error number displayed at the indoor unit or the wired remote controller by the said indoor unit when the error is occurred.

### 1 When the error is occurred at the indoor unit #1

- The indoor unit #1 is stopped and the base station controller displays the error code.
- At this time, the normal indoor unit #2 is automatically run.
  - ※ Even when it is restored to the normal condition, the indoor unit #2 is run until the rotary running time.

[Error Message]  
01 S.F. ERROR CODE

### 2 When the error is occurred at the indoor unit #2

- The indoor unit #2 is stopped and the base station controller displays the error code.
- At this time, the normal indoor unit #1 is automatically run.
  - ※ Even when it is restored to the normal condition, the indoor unit #1 is run until the rotary running time.

[Error Message]  
02 S.F. ERROR CODE

### 3 When the indoor temperature rises to 30°C or higher

- Two indoor units are run and the base station controller displays the error code.
- The high temperature error alarm is generated.

[Error Message]  
High TEMP. Error

### 4 When the indoor temperature drops to 10°C or lower

- The said indoor unit is stopped and the base station controller displays the error code.

[Error Message]  
LOW TEMP. Error

### 5 When the temperature sensor of the base station controller is not connected

- The base station controller displays the error code.
- The high temperature error alarm is generated.

[Error Message]  
SENSOR Input Check

**6 When the indoor water leakage is detected**

- When the detecting signal is received from the sensor, the error message is displayed.
- The water leakage error alarm is displayed.

[Error Message]  
Leak WATER Error

**7 When the indoor fire is detected**

- When the detecting signal is received from the sensor, the error message is displayed.
- All running indoor units are stopped and the fire alarm is generated.

[Error Message]  
FIRE Detection

※ This function can be used only when a separate fire detecting sensor is connected.

**8 When the indoor humidity is higher than the maximum setting of the base station controller**

- The error message is displayed.

[Error Message]  
High HUMIDITY

**9 When the indoor humidity is lower than the minimum setting of the base station controller**

- The error message is displayed.

[Error Message]  
Low HUMIDITY

※ If two or more error messages are generated, when you press Up(▲) or Down(▼) button, all generated error messages up to now can be displayed.



## ■ Output definition when any alarm is generated

- ㉑ Fire detected: All outputs such as running air conditioner are stopped, and the display and the fire alarm are generated.  
(Normal : Normal: Relay Powerless Contact B Short) (Error: Relay Powerless Contact A Open)
- ㉒ Water leakage detected: The display and the water leakage alarm are generated.  
(Normal : Normal: Relay Powerless Contact B Short) (Error: Relay Powerless Contact A Open)
- ㉓ Humidity detected: The error message is displayed.  
(Upper/Lower limit error)
- ㉔ High temperature detected: If the temperature is 30°C or higher, the display and the high temperature error alarm are generated.  
(Normal : Normal: Relay Powerless Contact B Short) (Error: Relay Powerless Contact A Open)
- ㉕ Low temperature detected: If the temperature is 10°C or lower, the error message is displayed.
- ㉖ If there is no temperature sensor connection: The error message is displayed.
- ㉗ Air conditioner detected : The display and the Air conditioner Error alarm are generated.  
(Normal : Normal: Relay Powerless Contact B Short) (Error: Relay Powerless Contact A Open)

### ※ Note: Output terminal

